



Grayhill, Inc.

62S11-H9-040C

Nombor Bahagian:

62S11-H9-040C

Pengilang / jenama:

Grayhill, Inc.

Penerangan Produk

ROTARY ENCODER OPTICAL 32PPR

Helaian data:

 62S11-H9-040C.pdf

Status RoHS

 Lead percuma / RoHS Compliant

Kapal Dari

Hong Kong

Cara Penghantaran

DHL/Fedex/TNT/UPS/EMS

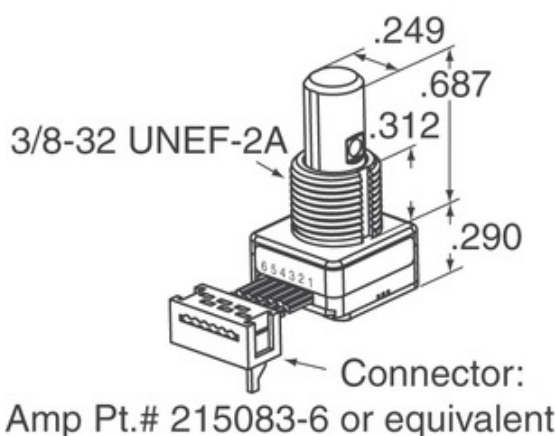
 Connector:
 Amp Pt.# 215083-6 or equivalent

Imej mungkin perwakilan. Lihat spesifikasi untuk butiran produk.

PERMINTAAN UNTUK SEBUT HARGA



Spesifikasi 62S11-H9-040C

NOMBOR BAHAGIAN	62S11-H9-040C
PENGELUAR	Grayhill, Inc.
PENERANGAN	ROTARY ENCODER OPTICAL 32PPR
STATUS STATUS PERCUMA / ROSH STATUS	Lead percuma / RoHS Compliant
LEMBARAN DATA	 62S11-H9-040C.pdf
VOLTAN - BEKALAN	5V
STYLE PENAMATAN	Cable with Connector
SIRI	62S
PUTARAN LIFE (CYCLES MIN)	1M
DENYUTAN PER REVOLUTION	32
JENIS OUTPUT	Quadrature (Incremental)
NAMA LAIN	62S11H9040C
ORIENTASI	Vertical
PEMASANGAN JENIS	Panel Mount
TAHAP SENSITIVITI LEMBAPAN (MSL)	1 (Unlimited)
PENGI LANG STANDARD LEAD TIME	8 Weeks
STATUS STATUS PERCUMA / ROSH STATUS	Lead free / RoHS Compliant
JENIS ENCODER	Optical
TURUTAN LAKARAN SASARAN	Yes
DIBINA PADA TUKAR	Yes
JENIS PENGGERAK	1/4" Dia Flatted End

Tag berkaitan

Grayhill, Inc. 62S11-H9-040C	Pengedar 62S11-H9-040C	Pembekal 62S11-H9-040C
Harga 62S11-H9-040C	Gambar 62S11-H9-040C	Imej 62S11-H9-040C
Datasheet PDF 62S11-H9-040C	Muat turun Datasheet 62S11-H9-040C	Datasheet 62S11-H9-040C
Stok 62S11-H9-040C	Beli 62S11-H9-040C	Beli Grayhill, Inc. 62S11-H9-040C
Grayhill, Inc. 62S11-H9-040C	Pembekal Grayhill, Inc.	Pengedar Grayhill, Inc.
Grayhill, Inc. 62S11-H9-040C	Grayhill Inc. 62S11-H9-040C	

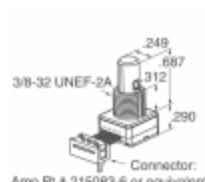
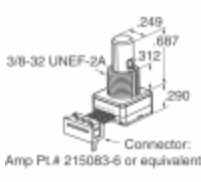
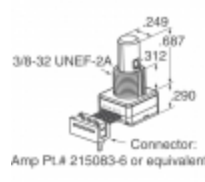
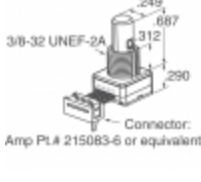
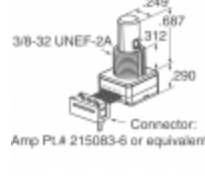
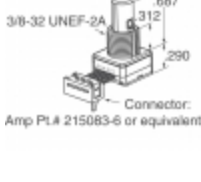
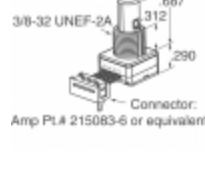
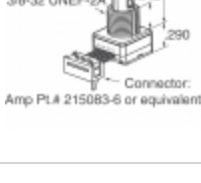
Produk Berkaitan

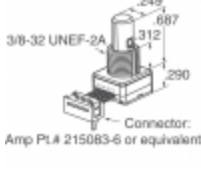
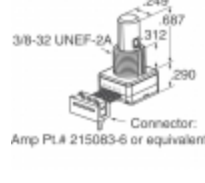
 <p>62S11-H0-P Pengilang: Grayhill, Inc. Penerangan: ROTARY ENCODER OPT 32PPR 10" CBL Dalam stok: Out stock</p> <p>RFQ</p>	 <p>62S11-H9-060C Pengilang: Grayhill, Inc. Penerangan: ROTARY ENCODER OPTICAL 32PPR Dalam stok: Out stock</p> <p>RFQ</p>
 <p>62S11-H0-200S Pengilang: Grayhill, Inc. Penerangan: ROTARY ENCODER OPTICAL 32PPR Dalam stok: Out stock</p> <p>RFQ</p>	 <p>62S11-H9-PH Pengilang: Grayhill, Inc. Penerangan: ROTARY ENCODER OPTICAL 32PPR Dalam stok: Out stock</p> <p>RFQ</p>
 <p>62S11-H9-P Pengilang: Grayhill, Inc. Penerangan: ROTARY ENCODER OPTICAL 32PPR Dalam stok: Out stock</p> <p>RFQ</p>	 <p>62S11-H0-PH Pengilang: Grayhill, Inc. Penerangan: ROTARY ENCODER OPTICAL 32PPR Dalam stok: Out stock</p> <p>RFQ</p>
 <p>62S11-H9-020S Pengilang: Grayhill, Inc. Penerangan: ROTARY ENCODER OPTICAL 32PPR Dalam stok: Out stock</p> <p>RFQ</p>	 <p>62S11-H9-040S Pengilang: Grayhill, Inc. Penerangan: ROTARY ENCODER OPTICAL 32PPR Dalam stok: Out stock</p> <p>RFQ</p>
 <p>62S11-H9-050S Pengilang: Grayhill, Inc. Penerangan: ROTARY ENCODER OPTICAL 32PPR Dalam stok: Out stock</p> <p>RFQ</p>	 <p>62S11-H9-025S Pengilang: Grayhill, Inc. Penerangan: ROTARY ENCODER OPTICAL 32PPR Dalam stok: Out stock</p> <p>RFQ</p>
 <p>62S11-H9-020C Pengilang: Grayhill, Inc. Penerangan: ROTARY ENCODER OPTICAL 32PPR Dalam stok: Out stock</p> <p>RFQ</p>	 <p>62S11-H9-060SH Pengilang: Grayhill, Inc. Penerangan: ROTARY ENCODER OPTICAL 32PPR Dalam stok: Out stock</p> <p>RFQ</p>

Hakcipta © 2020 Pengedar Elektronik yang Boleh Dipercayai - Ocean-Components.com

E-mel: Info@Ocean-Components.com

Alamat: Room 2102, Connaught Commercial Building, 185 Wan Chai Rd, Wan Chai, Hong Kong

