



Grayhill, Inc.

62S11-H9-PH

Nombor Bahagian:

62S11-H9-PH

Pengilang / jenama:

Grayhill, Inc.

Penerangan Produk

ROTARY ENCODER OPTICAL 32PPR

Helaian data:

 62S11-H9-PH.pdf

Status RoHS

 Lead percuma / RoHS Compliant

Kapal Dari

Hong Kong

Cara Penghantaran

DHL/Fedex/TNT/UPS/EMS

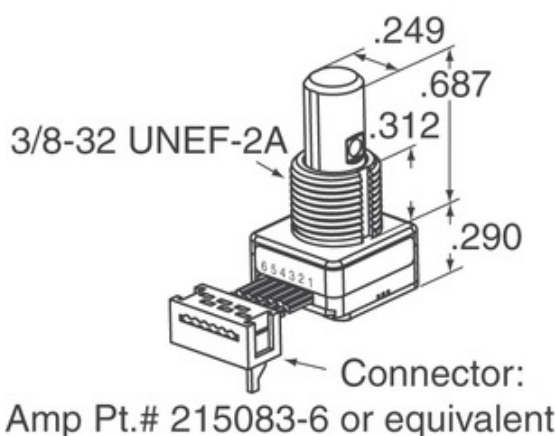

Imej mungkin perwakilan. Lihat spesifikasi untuk butiran produk.



Spesifikasi 62S11-H9-PH

| | |
|-------------------------------------|---|
| NOMBOR BAHAGIAN | 62S11-H9-PH |
| PENGELUAR | Grayhill, Inc. |
| PENERANGAN | ROTARY ENCODER OPTICAL 32PPR |
| STATUS STATUS PERCUMA / ROSH STATUS | Lead percuma / RoHS Compliant |
| LEMBARAN DATA |  62S11-H9-PH.pdf |
| VOLTAN - BEKALAN | 5V |
| STYLE PENAMATAN | PC Pin |
| SIRI | 62S |
| PUTARAN LIFE (CYCLES MIN) | 1M |
| DENYUTAN PER REVOLUTION | 32 |
| JENIS OUTPUT | Quadrature (Incremental) |
| NAMA LAIN | 62S11H9PH |
| ORIENTASI | Vertical |
| PEMASANGAN JENIS | PCB, Through Hole |
| TAHAP SENSITIVITI LEMBAPAN (MSL) | 1 (Unlimited) |
| PENGI LANG STANDARD LEAD TIME | 8 Weeks |
| STATUS STATUS PERCUMA / ROSH STATUS | Lead free / RoHS Compliant |
| JENIS ENCODER | Optical |
| TURUTAN LAKARAN SASARAN | Yes |
| DIBINA PADA TUKAR | Yes |
| JENIS PENGGERAK | 1/4" Dia Flatted End |

Tag berkaitan

| | | |
|----------------------------|----------------------------------|---------------------------------|
| Grayhill, Inc. 62S11-H9-PH | Pengedar 62S11-H9-PH | Pembekal 62S11-H9-PH |
| Harga 62S11-H9-PH | Gambar 62S11-H9-PH | Imej 62S11-H9-PH |
| Datasheet PDF 62S11-H9-PH | Muat turun Datasheet 62S11-H9-PH | Datasheet 62S11-H9-PH |
| Stok 62S11-H9-PH | Beli 62S11-H9-PH | Beli Grayhill, Inc. 62S11-H9-PH |
| Grayhill, Inc. 62S11-H9-PH | Pembekal Grayhill, Inc. | Pengedar Grayhill, Inc. |
| Grayhill, Inc. 62S11-H9-PH | Grayhill Inc. 62S11-H9-PH | |

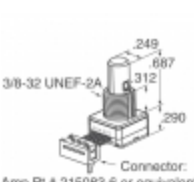
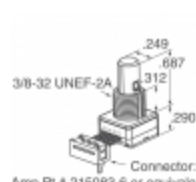
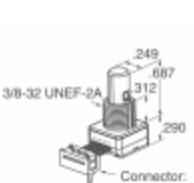
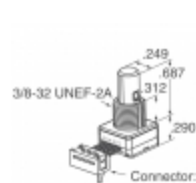
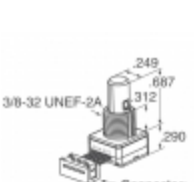
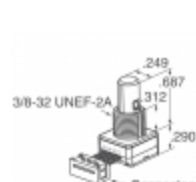
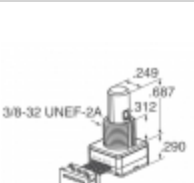
Produk Berkaitan

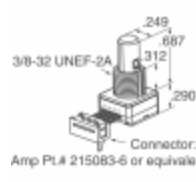
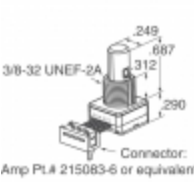
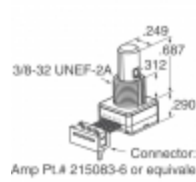
| | |
|--|---|
|  <p>62S11-L0-020C Pengilang: Grayhill, Inc. Penerangan: ROTARY ENCODER OPTICAL 32PPR Dalam stok: Out stock RFQ</p> |  <p>62S11-H9-050S Pengilang: Grayhill, Inc. Penerangan: ROTARY ENCODER OPTICAL 32PPR Dalam stok: Out stock RFQ</p> |
|  <p>62S11-L0-020CH Pengilang: Grayhill, Inc. Penerangan: ROTARY ENCODER OPTICAL 32PPR Dalam stok: Out stock RFQ</p> |  <p>62S11-L0-060CH Pengilang: Grayhill, Inc. Penerangan: ROTARY ENCODER OPTICAL 32PPR Dalam stok: Out stock RFQ</p> |
|  <p>62S11-H9-040C Pengilang: Grayhill, Inc. Penerangan: ROTARY ENCODER OPTICAL 32PPR Dalam stok: Out stock RFQ</p> |  <p>62S11-H9-P Pengilang: Grayhill, Inc. Penerangan: ROTARY ENCODER OPTICAL 32PPR Dalam stok: Out stock RFQ</p> |
|  <p>62S11-L0-055C Pengilang: Grayhill, Inc. Penerangan: ROTARY ENCODER OPTICAL 32PPR Dalam stok: Out stock RFQ</p> |  <p>62S11-H9-060SH Pengilang: Grayhill, Inc. Penerangan: ROTARY ENCODER OPTICAL 32PPR Dalam stok: Out stock RFQ</p> |
|  <p>62S11-L0-040S Pengilang: Grayhill, Inc. Penerangan: ROTARY ENCODER OPT 32PPR 4" CBL Dalam stok: Out stock RFQ</p> |  <p>62S11-H9-040S Pengilang: Grayhill, Inc. Penerangan: ROTARY ENCODER OPTICAL 32PPR Dalam stok: Out stock RFQ</p> |
|  <p>62S11-H9-060C Pengilang: Grayhill, Inc. Penerangan: ROTARY ENCODER OPTICAL 32PPR Dalam stok: Out stock RFQ</p> |  <p>62S11-L0-040C Pengilang: Grayhill, Inc. Penerangan: ROTARY ENCODER OPTICAL 32PPR Dalam stok: Out stock RFQ</p> |