



Grayhill, Inc.

**62S11-L0-040C**

Nombor Bahagian:

62S11-L0-040C

Pengilang / jenama:

Grayhill, Inc.

Penerangan Produk

ROTARY ENCODER OPTICAL 32PPR

Helaian data:

 62S11-L0-040C.pdf

Status RoHS



 Lead percuma / RoHS Compliant

Kapal Dari

Hong Kong

Cara Penghantaran

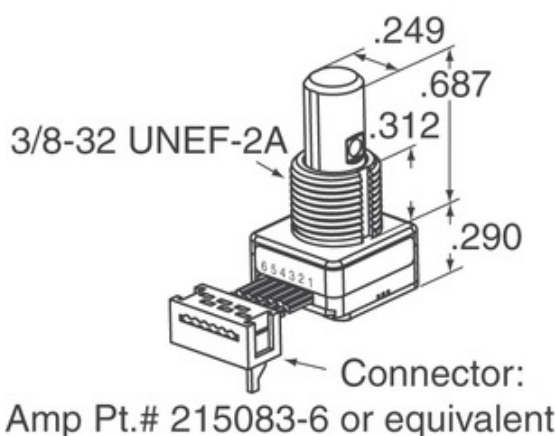
DHL/Fedex/TNT/UPS/EMS



Imej mungkin perwakilan. Lihat spesifikasi untuk butiran produk.

[PERMINTAAN UNTUK SEBUT HARGA](#)



## Spesifikasi 62S11-L0-040C

|                                     |   |
|-------------------------------------|---|
| NOMBOR BAHAGIAN                     | 62S11-L0-040C   |
| PENGELUAR                           | Grayhill, Inc.  |
| PENERANGAN                          | ROTARY ENCODER OPTICAL 32PPR  |
| STATUS STATUS PERCUMA / ROSH STATUS | Lead percuma / RoHS Compliant   |
| LEMBARAN DATA                       |  62S11-L0-040C.pdf |
| VOLTAN - BEKALAN                    | 5V  |
| STYLE PENAMATAN                     | Cable with Connector  |
| SIRI                                | 62S   |
| PUTARAN LIFE (CYCLES MIN)           | 1M  |
| DENYUTAN PER REVOLUTION             | 32  |
| JENIS OUTPUT                        | Quadrature (Incremental)  |
| NAMA LAIN                           | 62S11L0040C   |
| ORIENTASI                           | Vertical  |
| PEMASANGAN JENIS                    | Panel Mount   |
| TAHAP SENSITIVITI LEMBAPAN (MSL)    | 1 (Unlimited)   |
| PENGI LANG STANDARD LEAD TIME       | 8 Weeks   |
| STATUS STATUS PERCUMA / ROSH STATUS | Lead free / RoHS Compliant  |
| JENIS ENCODER                       | Optical   |
| TURUTAN LAKARAN SASARAN             | Yes   |
| DIBINA PADA TUKAR                   | No  |
| JENIS PENGGERAK                     | 1/4" Dia Flatted End  |

## Tag berkaitan

|                              |                                    |                                   |
|------------------------------|------------------------------------|-----------------------------------|
| Grayhill, Inc. 62S11-L0-040C | Pengedar 62S11-L0-040C             | Pembekal 62S11-L0-040C            |
| Harga 62S11-L0-040C          | Gambar 62S11-L0-040C               | Imej 62S11-L0-040C                |
| Datasheet PDF 62S11-L0-040C  | Muat turun Datasheet 62S11-L0-040C | Datasheet 62S11-L0-040C           |
| Stok 62S11-L0-040C           | Beli 62S11-L0-040C                 | Beli Grayhill, Inc. 62S11-L0-040C |
| Grayhill, Inc. 62S11-L0-040C | Pembekal Grayhill, Inc.            | Pengedar Grayhill, Inc.           |
| Grayhill, Inc. 62S11-L0-040C | Grayhill Inc. 62S11-L0-040C        |                                   |

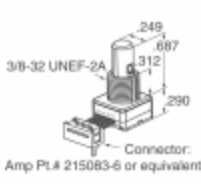
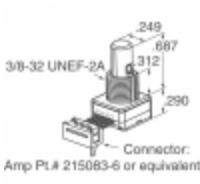
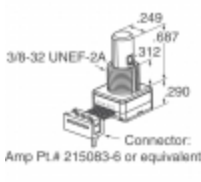
## Produk Berkaitan

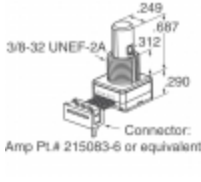
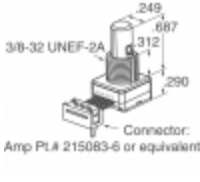
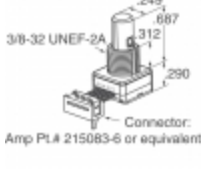
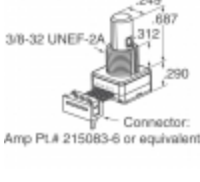
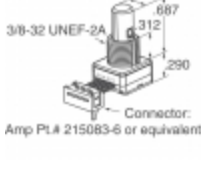
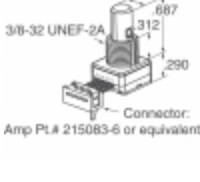
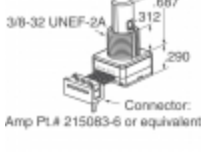
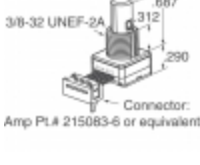
|  |   |
|--|---|
|  <p><b>62S11-L0-P</b><br/>         Pengilang: Grayhill, Inc.<br/>         Penerangan: ROTARY ENCODER OPTICAL 32PPR<br/>         Dalam stok: Out stock</p> <p><a href="#">RFQ</a></p>     |  <p><b>62S11-H9-060SH</b><br/>         Pengilang: Grayhill, Inc.<br/>         Penerangan: ROTARY ENCODER OPTICAL 32PPR<br/>         Dalam stok: Out stock</p> <p><a href="#">RFQ</a></p>   |
|  <p><b>62S11-L0-055C</b><br/>         Pengilang: Grayhill, Inc.<br/>         Penerangan: ROTARY ENCODER OPTICAL 32PPR<br/>         Dalam stok: Out stock</p> <p><a href="#">RFQ</a></p>  |  <p><b>62S11-L0-040S</b><br/>         Pengilang: Grayhill, Inc.<br/>         Penerangan: ROTARY ENCODER OPT 32PPR 4" CBL<br/>         Dalam stok: Out stock</p> <p><a href="#">RFQ</a></p> |
|  <p><b>62S11-H9-060C</b><br/>         Pengilang: Grayhill, Inc.<br/>         Penerangan: ROTARY ENCODER OPTICAL 32PPR<br/>         Dalam stok: Out stock</p> <p><a href="#">RFQ</a></p>  |  <p><b>62S11-L0-060CH</b><br/>         Pengilang: Grayhill, Inc.<br/>         Penerangan: ROTARY ENCODER OPTICAL 32PPR<br/>         Dalam stok: Out stock</p> <p><a href="#">RFQ</a></p>   |
|  <p><b>62S11-L0-060S</b><br/>         Pengilang: Grayhill, Inc.<br/>         Penerangan: ROTARY ENCODER OPTICAL 32PPR<br/>         Dalam stok: Out stock</p> <p><a href="#">RFQ</a></p>  |  <p><b>62S11-L0-020CH</b><br/>         Pengilang: Grayhill, Inc.<br/>         Penerangan: ROTARY ENCODER OPTICAL 32PPR<br/>         Dalam stok: Out stock</p> <p><a href="#">RFQ</a></p>   |
|  <p><b>62S11-L0-060SH</b><br/>         Pengilang: Grayhill, Inc.<br/>         Penerangan: ROTARY ENCODER OPTICAL 32PPR<br/>         Dalam stok: Out stock</p> <p><a href="#">RFQ</a></p> |  <p><b>62S11-H9-PH</b><br/>         Pengilang: Grayhill, Inc.<br/>         Penerangan: ROTARY ENCODER OPTICAL 32PPR<br/>         Dalam stok: Out stock</p> <p><a href="#">RFQ</a></p>      |
|  <p><b>62S11-L0-020C</b><br/>         Pengilang: Grayhill, Inc.<br/>         Penerangan: ROTARY ENCODER OPTICAL 32PPR<br/>         Dalam stok: Out stock</p> <p><a href="#">RFQ</a></p>  |  <p><b>62S11-H9-P</b><br/>         Pengilang: Grayhill, Inc.<br/>         Penerangan: ROTARY ENCODER OPTICAL 32PPR<br/>         Dalam stok: Out stock</p> <p><a href="#">RFQ</a></p>       |