



Grayhill, Inc.

62S11-H9-060C

Nombor Bahagian:

62S11-H9-060C

Pengilang / jenama:

Grayhill, Inc.

Penerangan Produk

ROTARY ENCODER OPTICAL 32PPR

Helaian data:

 62S11-H9-060C.pdf

Status RoHS

 Lead percuma / RoHS Compliant

Kapal Dari

Hong Kong

Cara Penghantaran

DHL/Fedex/TNT/UPS/EMS

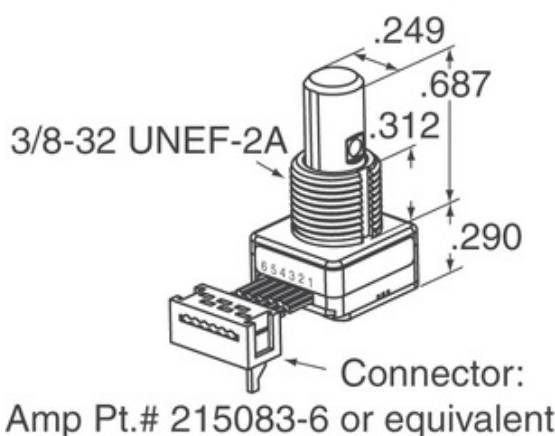

Imej mungkin perwakilan. Lihat spesifikasi untuk butiran produk.

[PERMINTAAN UNTUK SEBUT HARGA](#)

Spesifikasi 62S11-H9-060C

NOMBOR BAHAGIAN	62S11-H9-060C
PENGLUAR	Grayhill, Inc.
PENERANGAN	ROTARY ENCODER OPTICAL 32PPR
STATUS STATUS PERCUMA / ROSH STATUS	Lead percuma / RoHS Compliant
LEMBARAN DATA	 62S11-H9-060C.pdf
VOLTAN - BEKALAN	5V
STYLE PENAMATAN	Cable with Connector
SIRI	62S
PUTARAN LIFE (CYCLES MIN)	1M
DENYUTAN PER REVOLUTION	32
JENIS OUTPUT	Quadrature (Incremental)
NAMA LAIN	62S11H9060C
ORIENTASI	Vertical
PEMASANGAN JENIS	Panel Mount
TAHAP SENSITIVITI LEMBAPAN (MSL)	1 (Unlimited)
PENGLANG STANDARD LEAD TIME	8 Weeks
STATUS STATUS PERCUMA / ROSH STATUS	Lead free / RoHS Compliant
JENIS ENCODER	Optical
TURUTAN LAKARAN SASARAN	Yes
DIBINA PADA TUKAR	Yes
JENIS PENGGERAK	1/4" Dia Flatted End

Tag berkaitan

Grayhill, Inc. 62S11-H9-060C	Pengedar 62S11-H9-060C	Pembekal 62S11-H9-060C
Harga 62S11-H9-060C	Gambar 62S11-H9-060C	Imej 62S11-H9-060C
Datasheet PDF 62S11-H9-060C	Muat turun Datasheet 62S11-H9-060C	Datasheet 62S11-H9-060C
Stok 62S11-H9-060C	Beli 62S11-H9-060C	Beli Grayhill, Inc. 62S11-H9-060C
Grayhill, Inc. 62S11-H9-060C	Pembekal Grayhill, Inc.	Pengedar Grayhill, Inc.
Grayhill, Inc. 62S11-H9-060C	Grayhill Inc. 62S11-H9-060C	

Produk Berkaitan

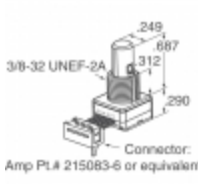
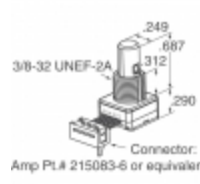
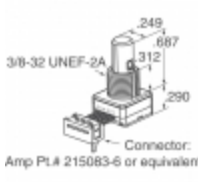
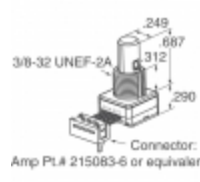
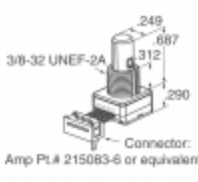
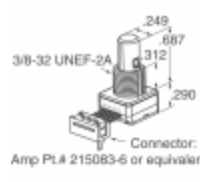
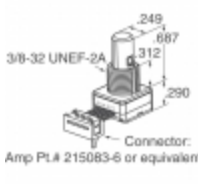
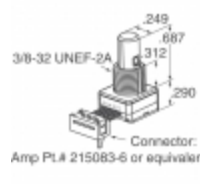
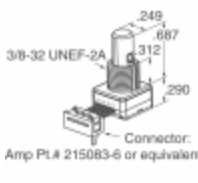
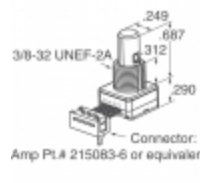
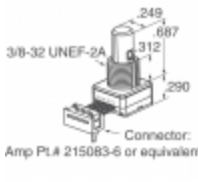
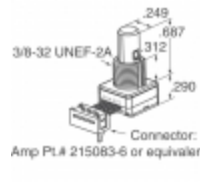
 <p>62S11-L0-020CH Pengilang: Grayhill, Inc. Penerangan: ROTARY ENCODER OPTICAL 32PPR Dalam stok: Out stock RFQ</p>	 <p>62S11-H9-PH Pengilang: Grayhill, Inc. Penerangan: ROTARY ENCODER OPTICAL 32PPR Dalam stok: Out stock RFQ</p>
 <p>62S11-L0-040C Pengilang: Grayhill, Inc. Penerangan: ROTARY ENCODER OPTICAL 32PPR Dalam stok: Out stock RFQ</p>	 <p>62S11-H9-P Pengilang: Grayhill, Inc. Penerangan: ROTARY ENCODER OPTICAL 32PPR Dalam stok: Out stock RFQ</p>
 <p>62S11-H9-020S Pengilang: Grayhill, Inc. Penerangan: ROTARY ENCODER OPTICAL 32PPR Dalam stok: Out stock RFQ</p>	 <p>62S11-H9-050S Pengilang: Grayhill, Inc. Penerangan: ROTARY ENCODER OPTICAL 32PPR Dalam stok: Out stock RFQ</p>
 <p>62S11-H9-060SH Pengilang: Grayhill, Inc. Penerangan: ROTARY ENCODER OPTICAL 32PPR Dalam stok: Out stock RFQ</p>	 <p>62S11-H9-040S Pengilang: Grayhill, Inc. Penerangan: ROTARY ENCODER OPTICAL 32PPR Dalam stok: Out stock RFQ</p>
 <p>62S11-H9-020C Pengilang: Grayhill, Inc. Penerangan: ROTARY ENCODER OPTICAL 32PPR Dalam stok: Out stock RFQ</p>	 <p>62S11-L0-020C Pengilang: Grayhill, Inc. Penerangan: ROTARY ENCODER OPTICAL 32PPR Dalam stok: Out stock RFQ</p>
 <p>62S11-H9-040C Pengilang: Grayhill, Inc. Penerangan: ROTARY ENCODER OPTICAL 32PPR Dalam stok: Out stock RFQ</p>	 <p>62S11-H9-025S Pengilang: Grayhill, Inc. Penerangan: ROTARY ENCODER OPTICAL 32PPR Dalam stok: Out stock RFQ</p>

Hakcipta © 2020 Pengedar Elektronik yang Boleh Dipercayai - Ocean-Components.com

E-mel: Info@Ocean-Components.com

Alamat: Room 2102, Connaught Commercial Building, 185 Wan Chai Rd, Wan Chai, Hong Kong

