

E-LOGO HERE
SEE EXPLODED VIEW

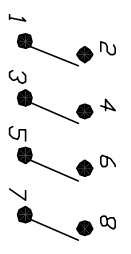
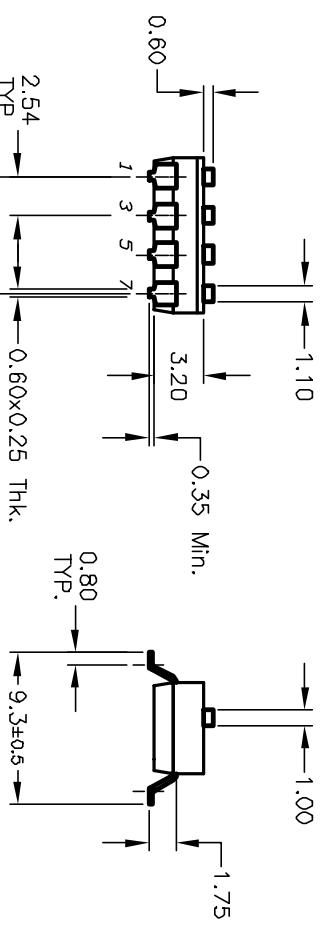
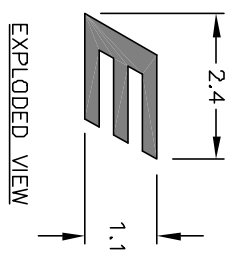

CIRCUIT 4 POSITION

NOTES:

1. ALL DIMENSIONS IN MM
2. GENERAL TOLERANCE: X.X=±0.4
X.XX=±0.25
3. TERM. NOS. FOR REFERENCE ONLY.
4. CONTACT RATINGS: 25mA @24VDC. (Switch)
100mA @50VDC. (Carry)
- ▲ 5. CONTACT MATERIAL:
CONTACTS: (MOVABLE) Copper w/Gold Plate
TERMINALS: BRASS w/Gold Plate
6. INSULATION RESISTANCE:
100 Mega-ohms min. @500VDC
7. CONTACT RESISTANCE:
50 MILLI-ohms typical @2-4VDC @100mA
8. OPERATING TEMP.:
-40°C to +80°C
9. PACKAGE: IN DISPENSING TUBES
WITH ALL POLES IN THE "OFF" POSITION.

RECOMMENDED P.C.B. LAYOUT

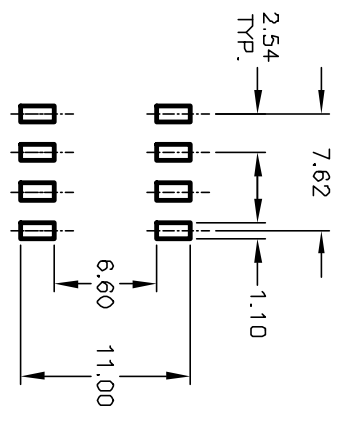

REV.	ECN No.	DESCRIPTION	DATE	CHKD
A	12540	RELEASED FOR PRODUCTION	7/1/02	CJB

TITLE	SCALE	DATE	DR	DWG	REV
KAJ04 LG GT (GOLD) EXTENDED ACTUATOR	2:1	7/1/02	CJB	W825124	A

E-SWITCH®

THE INFORMATION CONTAINED IN THIS DOCUMENT IS PROPRIETARY TO E-SWITCH AND IS NOT TO BE COPIED OR TRANSFERRED